

8 Pipe, Oil Feed			
Man Trans	R 078 145 778 B	m	.7 72.65
	L 078 145 777 B	m	.7 52.70
Auto Trans	R 078 145 778 B	m	.7 72.65
	L 078 145 777 C	m	.7 85.05
9 Distributor, Oil Pipe			
	078 115 377	m	22.55

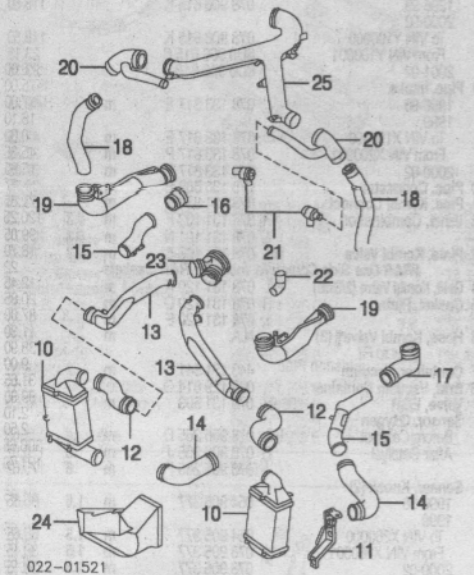

10 Intercooler			
2000	R 078 145 806 K	m	#1.3 308.65
	L 078 145 805 F	m	#1.3 308.65
2001			
To VIN 1109080	R 078 145 806 K	m	#1.3 308.65
	L 078 145 805 F	m	#1.3 308.65
From VIN 1109081	R 078 145 806 K	m	#1.3 308.65
	L 078 145 805 L	m	#1.3 308.65
	R 078 145 806 K	m	#1.3 308.65
	L 078 145 805 L	m	#1.3 308.65
<i>#w/ Front Bumper Removed, R&R Both 1.7</i>			
11 Brkt, Mounting	R 078 145 814 D		33.70
	L 078 145 813 J		25.25
12 Hose, Upper Pressure	R 078 145 746 E	m	#4 71.10
	L 078 145 745 A	m	#4 71.10
13 Pipe, Upper Pressure	R 078 145 686 C	m	#4 55.50
	L 078 145 683 D	m	#4 74.60
14 Hose, Frt Lwr Pressure	R 078 145 720 H	m	#4 44.25
	L 078 145 719 H	m	#4 52.25
15 Hose, Lwr Pressure	R 078 145 728 F	m	#4 85.05
	L 078 145 727 E	m	#4 108.20
16 Hose, Rear Lwr Pressure	078 145 720 C	m	#4 19.20
17 Hose, Rear Lwr Pressure	078 145 719 E	m	#4 52.25
<i>#Each Additional .2</i>			
18 Tube, Upper Air	R 078 133 610 C	m	61.80
	L 078 133 609 C	m	61.80
19 Tube, Lower Air	R 078 133 604 B	m	156.15
	L 078 133 603 A	m	156.15
20 Hose, Upr Connecting	R 078 133 241 B	m	38.75
	L 078 133 241 C	m	38.75
21 Valve, Cut-Off	R/L 034 145 710 C	m	1.0 47.95
22 Hose, Pressure	R 078 145 672	m	#3 25.80
	L 078 145 671 A	m	#3 25.80
23 Duct, Intake	078 133 356 T	m	#5 12.45
24 Duct, Air Cooler	R 480 117 336 B	m	#2 16.75
	L 480 117 335 B	m	#2 21.35
25 Hsg, Air Distribution			
Man Trans	078 133 351 C	m	#3 137.65
Auto Trans	078 133 351 E	m	#3 137.65

EXHAUST

1.8L ENG

R&R Exhaust System Complete #2.3
#Does Not Include Exhaust Manifold & Heat Shield

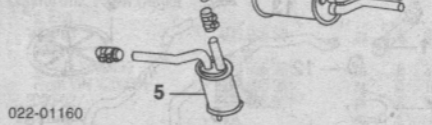
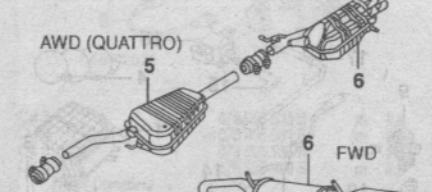
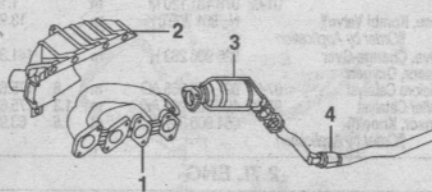

022-01160			
1 Manifold, Exhaust	058 253 033 E	m	1.8 290.40
2 Shield, Manifold	058 129 585 B	m	#6 13.40
<i>#Included in R&R Exhaust Manifold</i>			
3 Catalyst	480 254 200 X		1.0 R1019.00
4 Pipe, Front			
FWD			
Man Trans	380 253 301 H	.8	153.65
Auto Trans	800 253 301 CJ	.8	174.85
AWD Quattro			
Man Trans	800 253 301 CL	.8	157.80
Auto Trans	800 253 301 CN	.8	157.80
5 Muffler, Center			
FWD	97-99 800 253 409 T	1.1	278.05
	00-02 800 253 409 BM	1.1	465.25
AWD Quattro	97-99 800 253 409 AE	1.1	410.80
	00-02 800 253 409 CH	1.1	410.80
6 Muffler, Rear			
FWD	97-99 800 253 609 BR	.9	358.85
	00-02 800 253 609 BS	.9	312.90
AWD Quattro	800 253 609 AB	.9	338.90

2.7L ENG

R&R Exhaust System Complete #7.3
#Does Not Include R&R Exhaust Manifolds & Shields

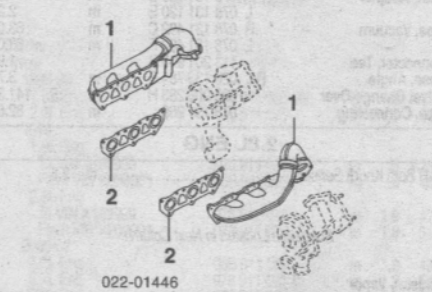

022-01446			
1 Manifold, Exhaust	R 078 253 034 DK	m	#2.3 694.00
	L 078 253 033 CT	m	#1.6 694.00
<i>#w/Engine/Trans Assy Removed, R&R Both Sides 3.2</i>			
2 Gasket, Manifold	R/L 078 253 039 G	m	6.20

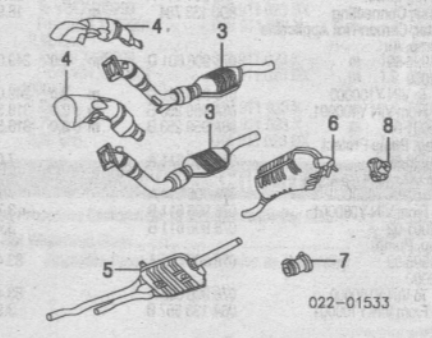

022-01533

3 Pipe w/Catalyst, Front			
Man Trans	R 8E0 253 058 BX	#4.5	1306.00
	L 8E1 253 057 AX	#4.5	1549.00
Auto Trans	R 8E0 253 058 CX	#4.5	1306.00
	L 8E0 253 057 JX	#4.5 R1	1306.00

#R&R Both Sides 6.2			
4 Shield, Heat Man Trans			
	R 078 129 598 N		24.85
	L 078 129 597 AC		40.40
Auto Trans			
	R 078 129 598 M		40.40
	L 078 129 597 AB		112.75
5 Muffler, Center	8D0 253 409 AJ	1.6	484.70
6 Muffler, Rear	8D0 253 609 BJ	.9	425.55
7 Clamp, Dual	R/L 357 253 141 A		27.30
<i>#As Required</i>			
8 Bracket, Rear	R 480 253 144 K		20.95
	L 8D0 253 144 N		18.60

2.8L ENG

R&R Exhaust System Complete #4.2
#Does Not Include Exhaust Manifolds & Shields

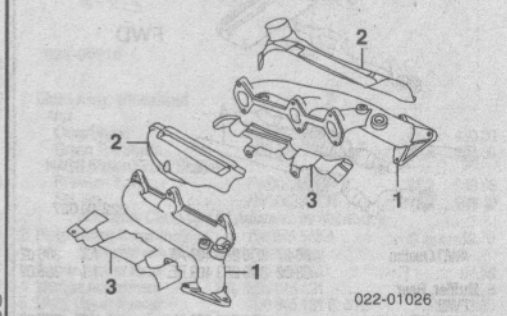

022-01026			
1 Manifold, Exhaust			
1996-97			
Cyl 1-3	078 253 032 AF	m	#5.0 205.05
Cyl 4-6	078 253 031 AF	m	#5.2 205.05
1998-99			
Cyl 1-3			
To VIN W180000	078 253 032 AP	m	#5.0 205.05
From VIN W180001	078 253 032 BA	m	#5.0 205.05
Cyl 4-6			
To VIN W180000	078 253 031 AN	m	#5.2 205.05
From VIN W180001	078 253 031 AS	m	#5.2 d199.65
2000-02			
Cyl 1-3	078 253 032 BA	m	#5.0 205.05
Cyl 4-6	078 253 031 BA	m	#5.2 205.05

#R&R Both Sides 6.7			
2 Shield, Upr Manifold			
1996-97			
	R 078 129 596 AA		13.95
	L 078 129 597 M		13.85
1998-99			
To VIN W180000	R 078 253 036		7.40
	L 078 253 037 E		7.15
From VIN W180001	R 078 253 036 D		9.00
	L 078 253 037 C		30.50
2000-02			
	R 078 253 036 D		9.00
	L 078 253 037 C		30.50
3 Shield, Lwr Manifold			
1996-97			
To VIN T100000	R 078 129 596 T		21.25
	L 078 129 595 G		13.45
From VIN T100001	R 078 129 596 T		21.25
	L 078 129 595 K		13.45
1998			
	R 078 253 008 A		10.70
	L 078 253 009 A		10.70
1999			
To VIN X199999	R 078 253 008 A		10.70
	L 078 253 009 A		10.70
From VIN X200001	R 078 253 008 B		30.50
	L 078 253 009 B		30.50
2000-02			
	R 078 253 008 B		30.50
	L 078 253 009 B		30.50

Illustration Located in Next Column

4 Pipe w/Catalyst, Front			
1996-97			
	R 8E0 253 096 KX	#1.6	R905.00
	L 8D0 253 057 BX	#2.0	1025.00
1998-99			
Man Trans	R 8D0 253 058 NX	#1.6	R905.00
	L 8D0 253 057 KX	#2.0	R905.00
Auto Trans	R 8D0 253 058 LX	#1.6	R905.00
	L 8D0 253 057 HX	#2.0	R905.00
2000-02			
Man Trans	R 8E0 253 058 KX	#1.6	1607.00
	L 8E1 253 057 AX	#2.0	1549.00
Auto Trans	R 8E0 253 058 MX	#1.6 R1	1306.00
	L 8E1 253 057 CX	#2.0 R1	1549.00

#R&R Both Sides 3.4			
5 Muffler, Center			
FWD			
1996-98			
	8D0 253 409 AG	1.1	386.02
1999			
To VIN X199999	8D0 253 409 AG	1.1	386.02
From VIN X200001	8D0 253 409 BD	1.1	484.70
2000-02	8D0 253 409 BD	1.1	484.70